

JUMBO FLAG

INSTRUCTIONS

3/10/2010

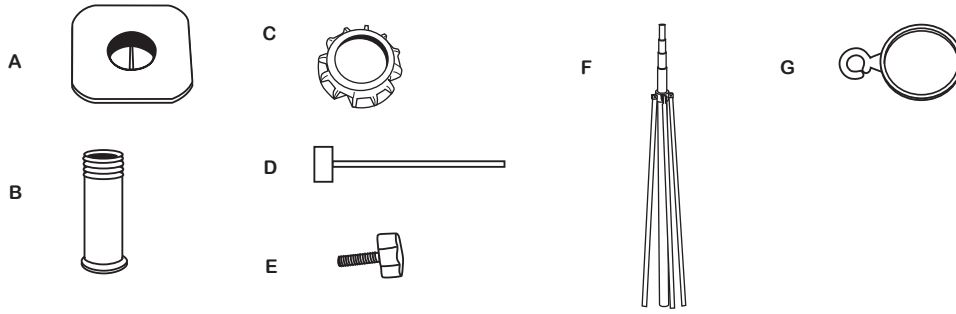

NOTE: If using a banner with sleeves instead of grommets, remove all the plastic rings.

A. Assemble the Base

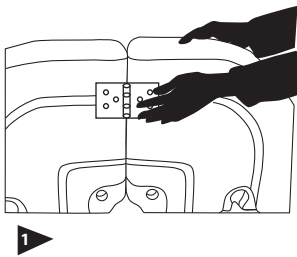

1 Unfold the base.

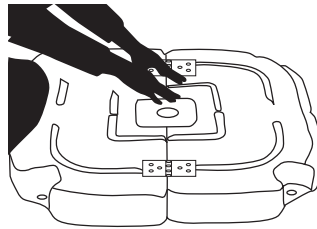

2 Place the top and bottom square connectors (A) in the center of the base.

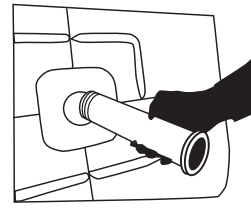

3 Insert the pole base (B) from the bottom with the threads on top.

B. Insert the Pole

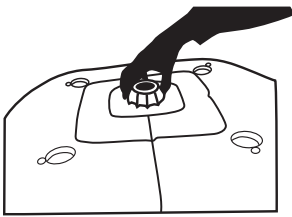

4 Secure the pole base (B) with the collar (C).



5 Place base in desired location and fill with water.

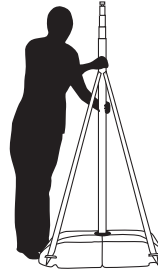

6 Place the mast (F) into the center hole and the four support poles in the holes in the corners.



7 Secure the support poles by pushing the locking plastic bracket into position.

Note: If the support legs don't reach the corners, loosen and lower the mast ring.

C. Attach the Graphic

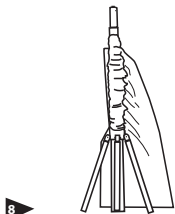

8 Place the sleeve on the side of the graphic over the mast pole.

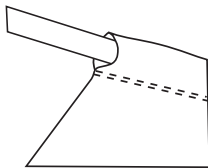

9 Insert the graphic bar (D) into the sleeve on the top of the banner.

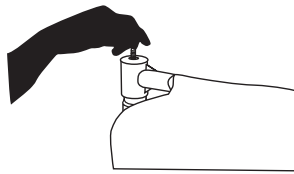

10 Secure the graphic (D) bar by screwing the thumb screw (E) into the top of the mast.

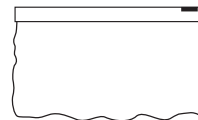

11 Locate the velcro tab at the end of the sleeve. Remove the protective backing and apply the adhesive layer directly to the pole.

Note: When removing the banner, unzip velcro pieces from each other.

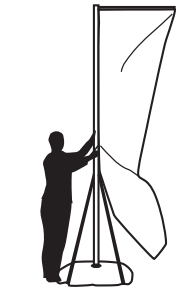

12 Lift the mast one section at a time, making sure that every section clicks into position.